

Handle Mounting Spacer Locations

(Side View)

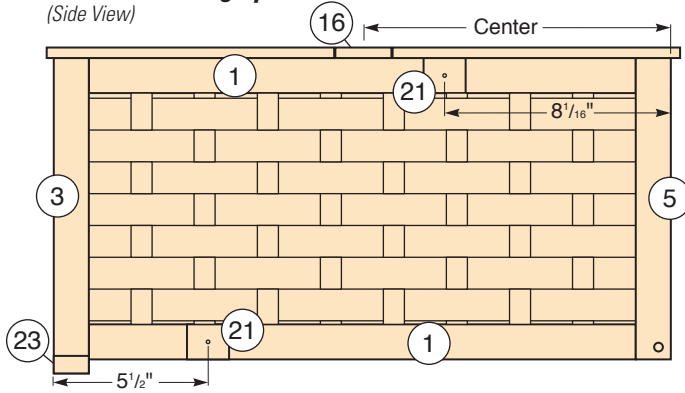

Handle Strip Hole Locations

(Side View)

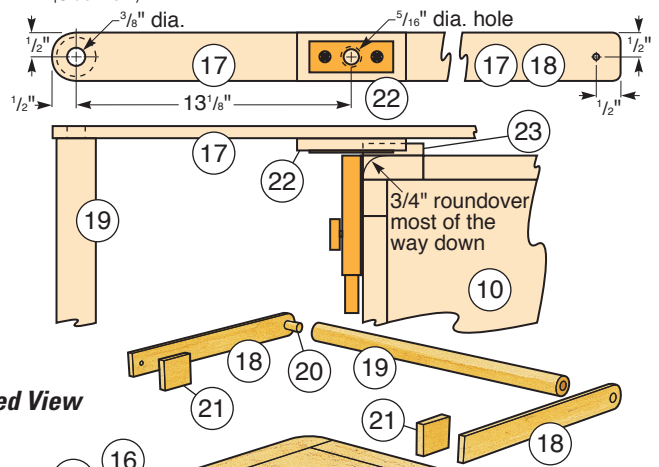

Corner Stiles

(Side View)

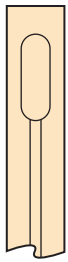

Lid Rails, Stiles

(End View)

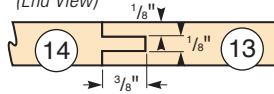

Lid Panel

(End View)



Lid Support Rail

(Top View)

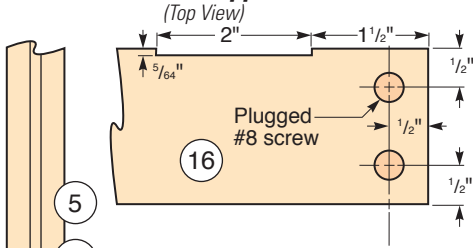

Basket Bottom Detail

(End View)

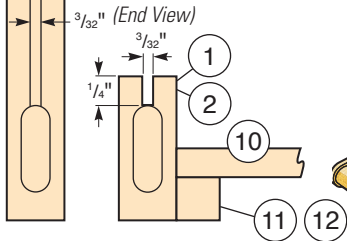

Exploded View

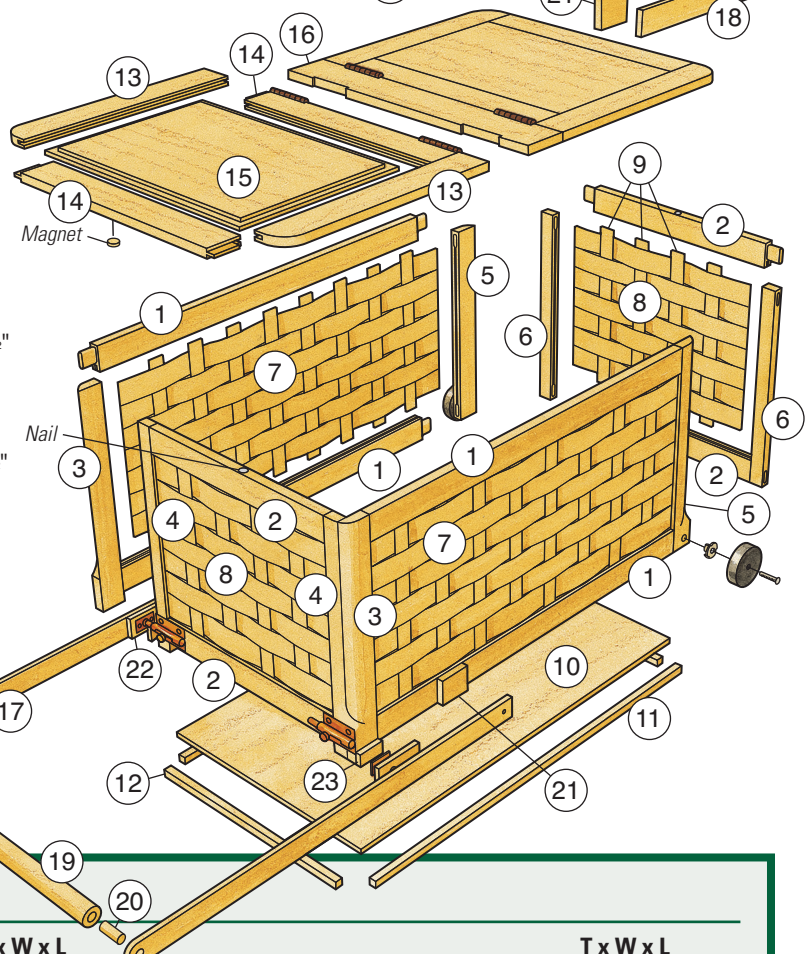

MATERIAL LIST

	T x W x L		T x W x L
1 Long Frame Rails (4)	1/2" x 1 1/4" x 19 1/2"	13 Lid Frame Stiles (4)	3/8" x 1 1/2" x 10 1/4"
2 Short Frame Rails (4)	1/2" x 1 1/4" x 10 1/2"	14 Lid Frame Rails (4)	3/8" x 1 1/2" x 11 1/4"
3 Long Wide Corner Stiles (2)	1/2" x 1 1/4" x 11 1/4"	15 Lid Panels (2)	1/4" x 7 13/16" x 11 3/16"
4 Long Narrow Corner Stiles (2)	1/2" x 3/4" x 11 1/4"	16 Lid Support Rail (1)	3/8" x 2" x 13 1/2"
5 Short Wide Corner Stiles (2)	1/2" x 1 1/4" x 10 3/4"	17 Long Handle Strips (2)	5/16" x 1" x 19 7/8"
6 Short Narrow Corner Stiles (2)	1/2" x 3/4" x 10 3/4"	18 Short Handle Strips (2)	5/16" x 1" x 10 7/8"
7 Long Horizontal Weaving Strips (14)	3/32" x 1 1/8" x 20"	19 Handle Grip Dowels (2)	13/16" dia. x 13 7/8"
8 Short Horizontal Weaving Strips (14)	3/32" x 1 1/8" x 11"	20 Handle Dowels (4)	3/8" dia. x 1"
9 Vertical Weaving Strips (24)	3/32" x 3/4" x 8 3/4"	21 Handle Mounting Spacers (4)	5/16" x 1 1/4" x 1 1/2"
10 Bottom (1)	1/4" x 12" x 21"	22 Long Handle Strike Strips (2)	1/4" x 1" x 2 1/4"
11 Long Bottom Support Strips (2)	3/8" x 3/8" x 21"	23 Long Handle Stops (2)	1/4" x 1 1/4" x 5/8"
12 Short Bottom Support Strips (2)	3/8" x 3/8" x 11 1/4"		