

**Exploded View**

*Note: Exploded View and Material List depict single-piece legs — see sidebar on page 45 for other options. To build the quadrilinear leg construction, see the Drawing and component list below.*

## MATERIAL LIST

	<b>T x W x L</b>
<b>1</b> Legs (4)	2¼" x 2¼" x 28¼"
<b>2</b> Front Rail (1)	¾" x 5¾" x 48"
<b>3</b> Back Bottom Rail (1)	¾" x 5¾" x 48"
<b>4</b> Back Top Rail (1)	¾" x 2¾" x 48"
<b>5</b> Side Bottom Rails (2)	¾" x 5¾" x 29"
<b>6</b> Side Top Rails (2)	¾" x 2¾" x 29"
<b>7</b> Stiles (11)	¾" x 2½" x 15"
<b>8</b> Side Panels (4)	¼" x 10¾" x 15"
<b>9</b> Back Panels (4)	¼" x 9¼" x 15"
<b>10</b> Corbels (7)	¾" x 3" x 19¼"
<b>11</b> Arm Back (1)	¾" x 6" x 56"
<b>12</b> Arm Sides (2)	¾" x 6" x 36"
<b>13</b> Front, Back Cleats (2)	¾" x 3¼" x 44½"
<b>14</b> Side Cleats (2)	¾" x 3¼" x 26½"
<b>15</b> Seat Frame Rails (2)	13/16" x 2" x 46¼"
<b>16</b> Seat Frame Stiles (3)	13/16" x 2" x 25¼"

### Quadrilinear Leg Components

**1** Leg Faces (16) ¾" x 2¼" x 28¼"

**2** Core (4) ¾" x ¾" x 29"

*Machine the core to fit the opening exactly once you have the leg faces cut to fit.*

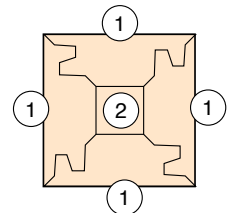

### Seat Frame Placement

(Side View)

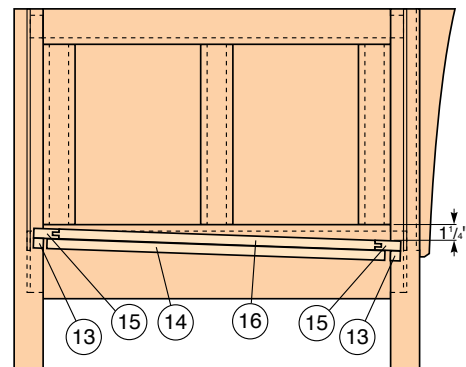

*Note: To provide a more comfortable seat position, the seat frame is attached to cleats that are offset. The rear cleat is lower than the front, and the side cleats are angled to accommodate the difference.*

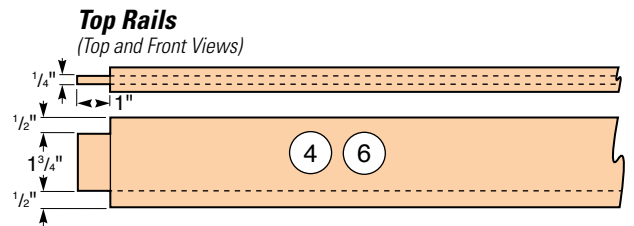
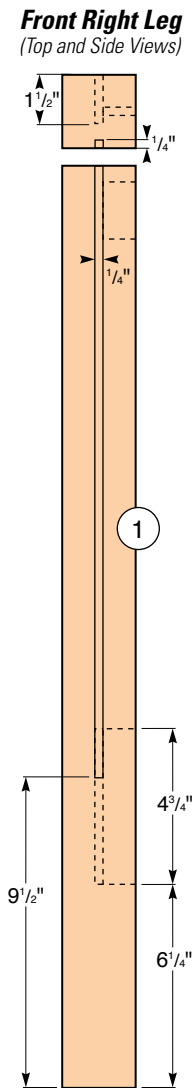
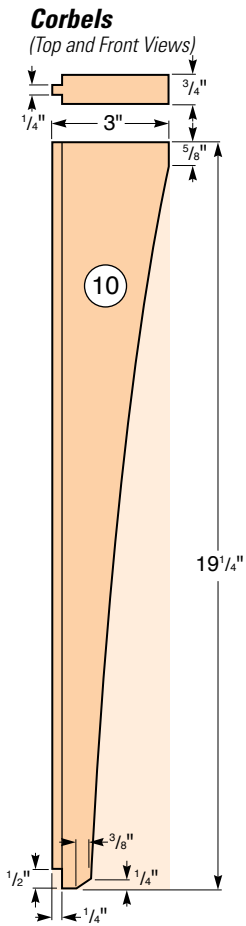
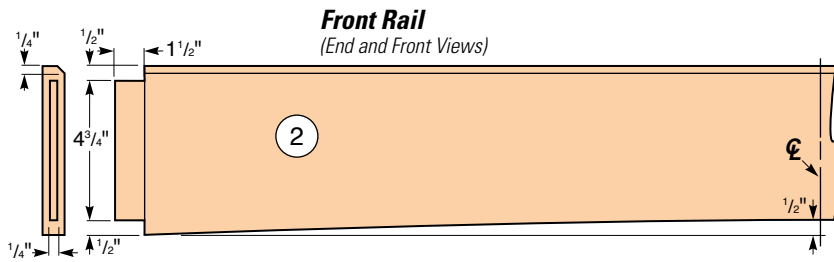

**Stiles**  
(Top and Front Views)

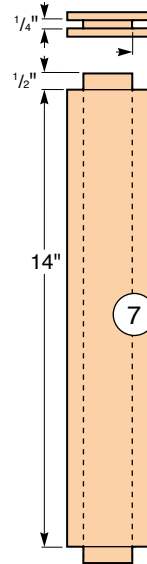

**Panels**  
(Front View)

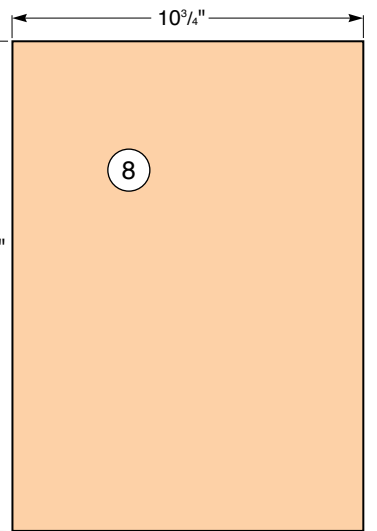

**Bottom Rails**  
(Top and Front Views)

